

KE010 Ver.2 / 외형도

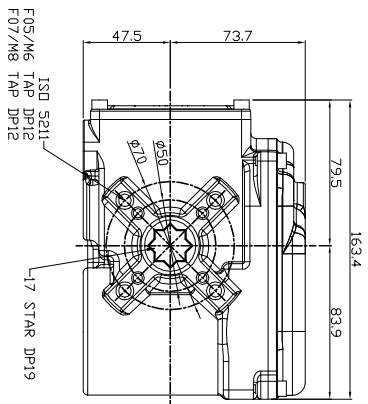
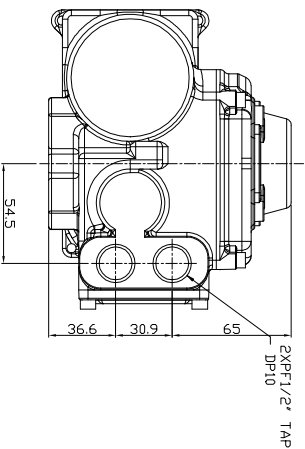
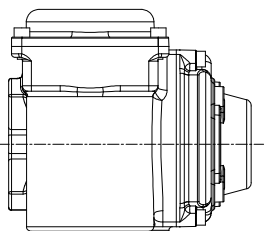
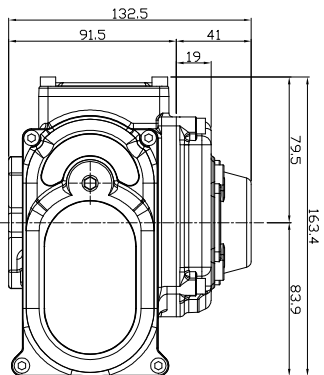
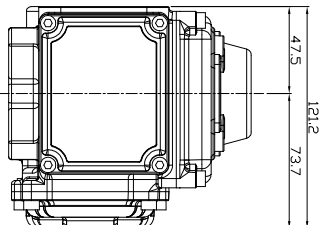
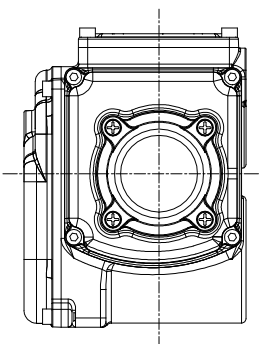

REV. NO.	REVISION DESCRIPTION	DRAWN / DATE	APPROVED / DATE
△	최초작성	노한기 / 180508	
△			

KOSAPLUS Co.,Ltd	
TITLE	KE010 Ver.2 외형도
DRAWING NO.	KE010-0000
REV.	0