

RACK&PINION / SPRING RETURN / RS115

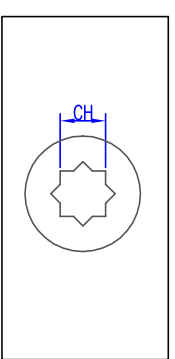

REV.NO.	REVISION DESCRIPTION	DRAWN / DATE	REVIEWED / DATE	APPROVED / DATE
△	최초작성	노봉아 / 150130		
△	-	-		

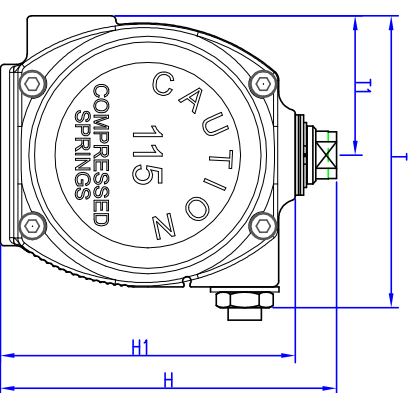
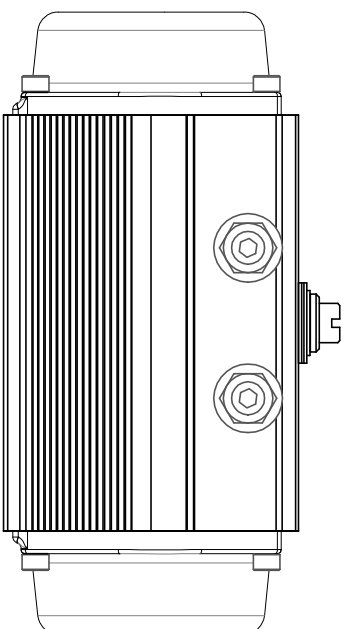
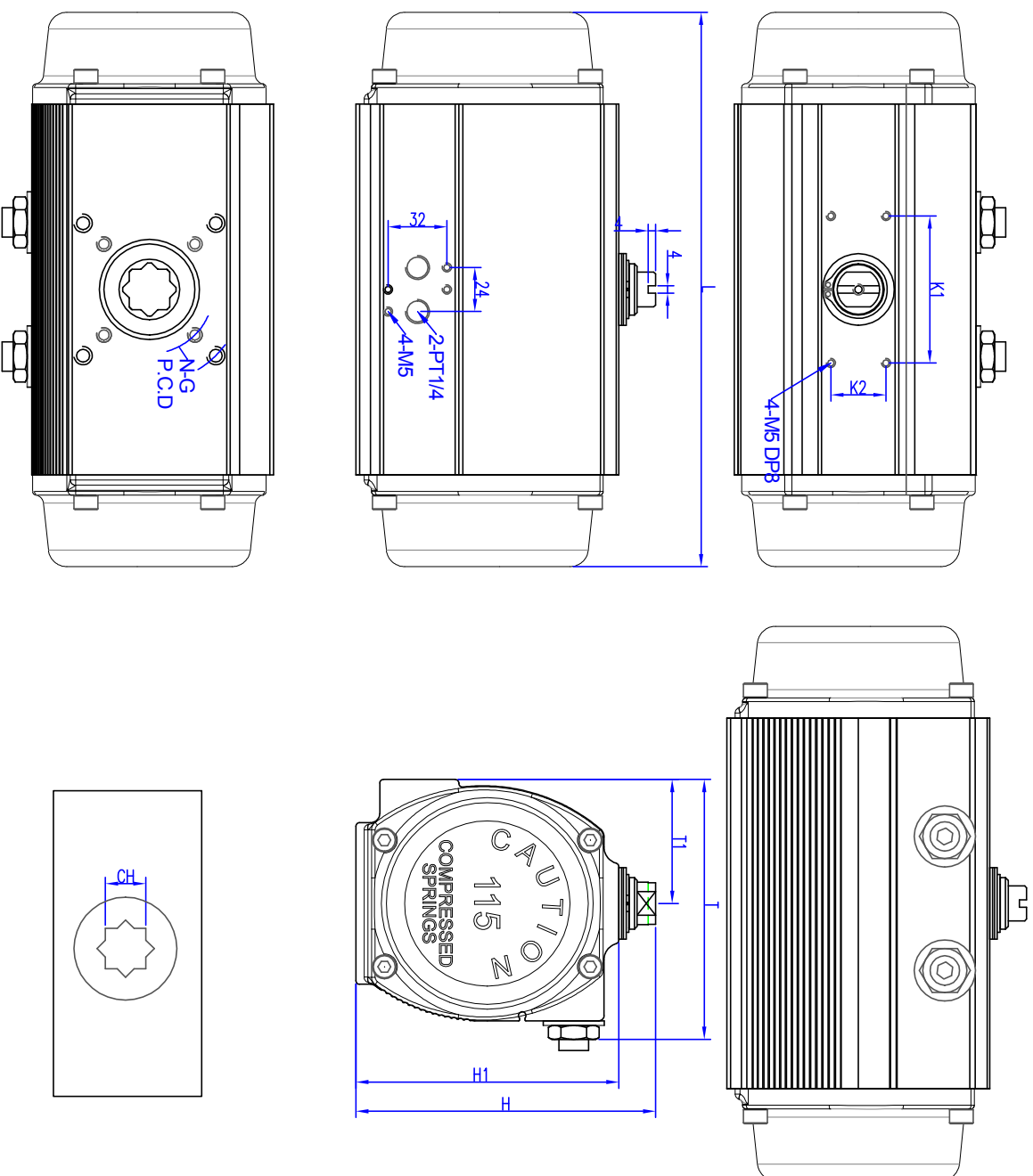
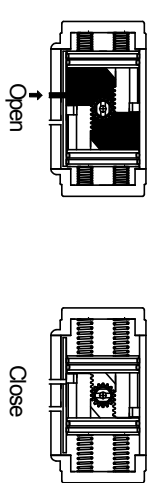

MAJOR PART LIST

NO.	PART NAME	MATERIAL
1	BODY	ALUMINUM
2	SHAFT	STEEL ALLOY (NICKEL COATING)
3	PISTON	ALUMINUM
4	COVER	ALUMINUM

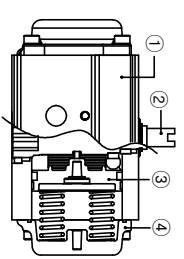

SPECIFICATIONS

1. Operating fluid : Compressed dry air
2. Operating pressure : 4Bar~7Bar
3. Operating temperature : -20~80°

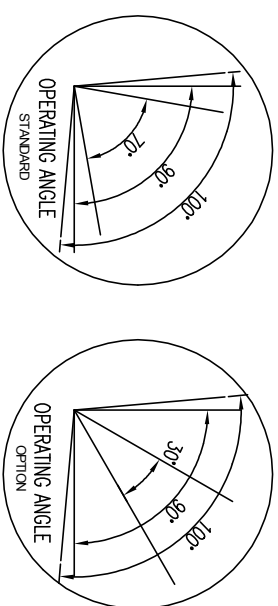

■ DIMENSION(mm)

MODEL	K1	K2	ISO	ØP.C.D	N-G(DP)	K	L	T	T1	H	H1	CH	DP	WEIGHT
RS115	80	30	F07/F10	70/102	-M8/M10(16/19)	19	302	141.5	67.5	163	143	22*22	26	-~kg

PRODUCT NAME Pneumatic actuator		TITLE DRAWING	
MODEL RS115	HARDNESS -	KOSAPLUS Co.,Ltd	
MATERIAL -	APPROVED DATE	DRAWING NO. PARS115-001	REV. 0