

# SCOTCH-YOKE / DOUBLE ACTING / AD125

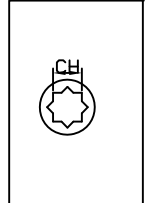

REV. NO.	REVISION DESCRIPTION	DRAWN / DATE	REVIEWED / DATE	APPROVED / DATE
△	스토퍼간격 및 밸브의 수정	노용아 / 130619		
△	포그새체	노용아 / 170828		

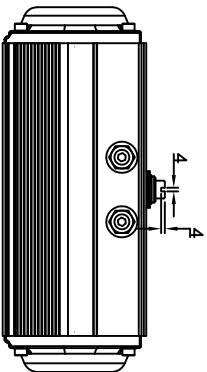
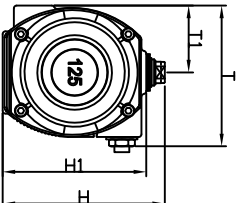
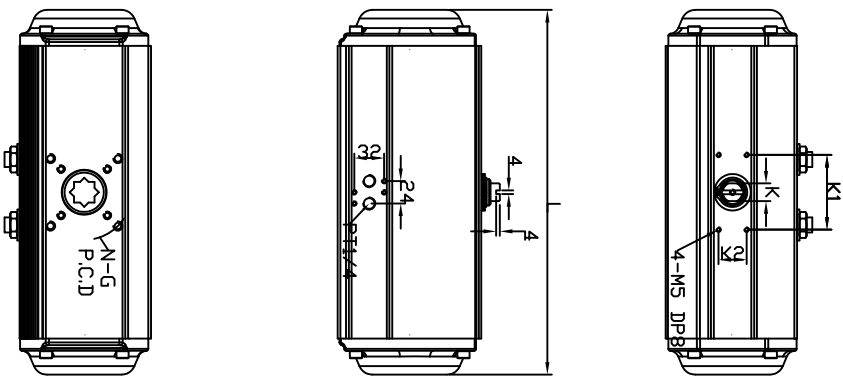
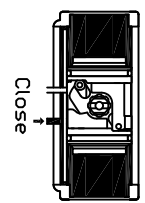
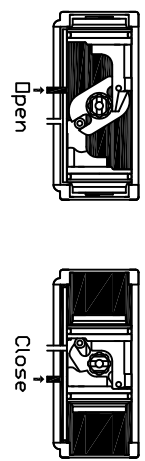

## MAJOR PART LIST

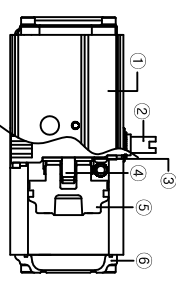

NO.	PART NAME	MATERIAL
1	BODY	ALUMINUM
2	SHAFT	STEEL ALLOY (NICKEL COATING)
3	SHAFT ROLLER	ENGINEERING PLASTIC
4	CRANK	STEEL ALLOY
5	PISTON	ALUMINUM
6	COVER	ALUMINUM

## SPECIFICATIONS

1. Operating fluid : Compressed dry air
2. Operating pressure : 4Bar~7Bar
3. Operating temperature : -20~80°

## ■ DIMENSION(mm)

MODEL	K1	K2	ISO	ØP.C.D	N-G(DP)	K	L	T	T1	H	H1	CH	DP	WEIGHT
AD125	80	30	F07/F10	70/102	4-M8/M10(16/19)	19	390	151	72	174	154	22*22	26	11.3kg

PRODUCT NAME Pneumatic actuator		TITLE DRAWING	
MODEL AD125	HARDNESS -	DRAWING NO. PAAD125-001	
DRAWING DATE	APPROVED DATE	REV. 7	

KOSAPLUS Co.,Ltd